

OWNER'S/OPERATOR'S MANUAL

WARNING:

Read this Manual, and any Supplements Carefully Before Operating Vehicle.

- Assembly
- Operation
- Maintenance

THIS VEHICLE IS NOT DESIGNED FOR USE ON RENTAL TRACKS OR RACING

KANDI KRUISER ELECTRIC GOLF CART

- **BEFORE OPERATING THIS VEHICLE, THE OWNER AND EACH OPERATOR MUST HAVE READ AND HAVE AN UNDERSTANDING OF ALL THE INSTRUCTIONS FOR PROPER ASSEMBLY AND SAFE OPERATION, AS WELL AS THE INSTRUCTIONS CONCERNING THE ENGINE AND ALL OTHER PORTIONS OF THE VEHICLE.**

NOTE: A storage area/toolbox has been provided on the VEHICLE for storage of this manual.

Please keep this manual in storage so that it can be found easily and referenced when needed.

CONTENTS

| | |
|--------------------------------|------|
| 1. INTRODUCTION | 1.1 |
| 2. UNDERSTANDING WARNING | 2.1 |
| 3. SAFETY WARNING | 3.1 |
| 4. PRE-RIDE | 4.1 |
| 5. OPERATION WARNING | 5.1 |
| 6. V.I.N. NUMBER | 6.1 |
| 7. CONTROL AND FUNCTIONS | 7.1 |
| 8. RIDING GEAR | 8.1 |
| 9. BATTERY | 9.1 |
| 10. MAINTENANCE | 10.1 |
| 11. TROUBLE SHOOTING | 11.1 |
| 12. SPECIFICATION | 12.1 |

1. INTRODUCTION

Introduction

Congratulations on the purchase of your Utility Task Vehicle. We take pride in offering you this product engineered and manufactured to the highest performance and quality standards. We are sure that you will enjoy superior levels of performance, reliability, riding comfort, and safety.

This manual is provided to help the owner and operators of this VEHICLE become familiar with the operating characteristic, and the many features offered on the VEHICLE. The manual also covers information on the care and maintenance of your VEHICLE.

Please read this manual carefully. The information contained in this Owner's Manual, the Warning Labels supplied with this product will help you to understand the safe use and maintenance of your VEHICLE. Make sure that you understand and follow all Warnings and Instructions in this material.

If you did not receive any of the material listed above, please call your dealer and request to have them sent to you.

For customer service, please email to info@scautosports.com.

Product and specifications are subject to change without notice.

1. INTRODUCTION

Important Safety Notice

● This vehicle is designed and manufactured for off-road use only. It is illegal to operate this vehicle on any public street, road, or highway. Such use is prohibited by law.

● Check the laws and regulations in force before choosing where to operate this vehicle. It is illegal to operate this vehicle on public lands where vehicles its size are prohibited.

● Never make any modifications to the engine, drive system, mechanical or electrical systems of your VEHICLE. Never install aftermarket parts or accessories intended to increase the speed or power of your VEHICLE.

● Failure to follow these warnings increases the possibility of accidents leading to **DEATH** or **SERIOUS INJURY!**

● Additionally, failure to follow these requirements will void the Warranty on your VEHICLE.

NOTE

The addition and use of certain accessories including, (but not limited to) mowers, blades, sprayers, winches and windshields will change the handling characteristics and the performance of your VEHICLE.

Practice Responsible VEHICLE Riding

Make sure that you understand and follow all local, state/province, and federal/national riding laws and requirements.

Remember

Respect your vehicle, respect the environment and respect the property of others. You are responsible for your safety and the safety of others around you when you ride!

1. INTRODUCTION

A VEHICLE CAN BE HAZARDOUS TO OPERATE.

A VEHICLE handles differently from other vehicles including motorcycles, ATVs and cars. A collision rollover can occur quickly, even during routine maneuvers such as turning and driving on hills or over obstacles, if you fail to take proper precautions.



SERIOUS INJURY OR DEATH

can result if you do not follow these instructions.

- Read this manual and all labels carefully and follow the operating procedures described.
- This vehicle is designed to carry the driver and one passenger. Never carry passengers in the cargo bed.
- Always be sure the driver and passenger are wearing seat belts.
- Never allow anyone who is not an adult to operate this VEHICLE.
- Never permit a guest to operate this VEHICLE unless the guest has read this manual and all product labels.
- The driver and passenger must wear approved off-road motorcycle -type helmets that fit properly. The driver and passenger should also wear eye protections (glasses or face shields), gloves, boots, long-sleeved shirts or jackets, and long pants.
- As with any off-road-capable vehicle, there is a risk of tip over or rollover under certain conditions. Uneven terrain or slopes which pitch the vehicle sideways, turning too fast or sharp, or a combination of conditions increase the risk of tip over.

If you are in a situation where the vehicle is tipping over, do not put your arm or/ and leg outside the vehicle, do not try to stop tipping with your arm or leg. You could be severely injured. You could suffer a crushed hand, arm, leg, or foot, if part of your body is caught underneath the vehicle.

You must keep your arms and legs inside the vehicle until it has stopped moving.

- Never consume alcohol or drugs before or while operating this VEHICLE.
- Never operate at excessive speeds. Always travel at a speed which is proper for the terrain, visibility and operating conditions, and your experience.
- Never attempt wheelies, jumps or other stunts.
- Always inspect your VEHICLE each time you use it to make sure it is in safe operating condition. Always follow the inspection and maintenance procedures and schedules described in this manual.
- Always keep hands, arms, feet, and legs inside the vehicle at all times during

1. INTRODUCTION

operation. Keep your feet on the floorboard. Never hold onto the enclosure except when using the handgrip inside the enclosure. Otherwise, your hand could be injured if it is caught between the enclosure and an obstacle outside the vehicle.

- Always keep both hands on the steering wheel when driving.
- Never wrap your thumbs and fingers around the steering wheel. This is particularly important when driving in rough terrain. The front wheels will move right and left as they respond to the terrain, and this movement will be felt in the steering wheel. A sudden jolt could wrench the steering wheel around, and your thumbs or fingers could be injured if they are in the way of the steering wheel spokes.
- Always go slowly and be extra careful when operating on unfamiliar terrain. Always be alert to changing terrain conditions when operating the VEHICLE.
- Never operate on excessively rough, slippery or loose terrain.
- Always follow proper procedures for turning as described in this manual. Practice turning at low speeds before attempting to turn at faster speeds. Do not turn at excessive speed.
- Always have the VEHICLE checked by an authorized dealer if it has been involved in an accident.
- Never operate VEHICLE on hills too steep for the VEHICLE or for your abilities. Practice on smaller hills before attempting larger hills.
- Always follow proper procedures for climbing hills as described in this manual. Check the terrain carefully before you start up any hill. Never climb hills with excessively slippery or loose surfaces. Never open throttle suddenly or make sudden gear changes. Never go over the top of any hill at high speed.
- Always follow proper procedures for going down hills and for braking on hills as described in this manual. Check the terrain carefully before you start down any hill. Never go down a hill at high speed. Avoid going down a hill at an angle which would cause the vehicle to lean sharply to one side. Go straight down the hill where possible.
- Always follow proper procedures for crossing the side of a hill as described in this manual. Avoid hills with excessively slippery or loose surfaces. Never attempt to turn the VEHICLE around on any hill. Avoid crossing the side of a steep hill if possible.
- Always use proper procedures if you stall or roll backwards when climbing a hill. To avoid stalling, maintain a steady speed when climbing a hill. If you stall or roll backwards, follow the special procedure for braking described in this manual.
- Always check for obstacles before operating in a new area. Never attempt to operate over large obstacles, such as large rocks or fallen trees. Always follow

1. INTRODUCTION

proper procedures when operating over obstacles as described in this manual.

- Always be careful of skidding or sliding. On slippery surfaces, such as ice, go slowly and be very cautious in order to reduce the chance of skidding or sliding out of control.
- Avoid operating the VEHICLE through deep or fast flowing water. Avoid water which exceeds the recommended maximum depth. Go slowly, carefully avoiding sudden movements, maintain a slow and steady forward motion, do not make sudden turns or stops, and do not make sudden throttle changes.
- Wet brakes may have reduced stopping ability. Test your brakes after leaving water. If necessary apply them lightly several times to let friction dry out the pads.
- Always be sure there are no obstacles or people behind you when you operate in reverse. When it is safe to proceed in reverse, go slowly. Avoid turning at sharp angles in reverse.
- Always use the size and type tires specified in this manual. Always maintain proper tire pressure as described in this manual.
- Never modify A VEHICLE through improper installation or use of accessories.
- Never exceed the stated load capacity. Cargo should be as far forward in the bed as possible, and distributed evenly from side to side. Be sure cargo is secured so that it cannot move around during operation. Reduce speed and follow instructions in this manual for carrying cargo or pulling a trailer. Allow greater distance for braking.

2. UNDERSTANDING WARNINGS

ATTENTION:

This is an ADULT VEHICLE ONLY! Not a toy!
READ AND UNDERSTAND WARNINGS AND OWNER'S MANUAL BEFORE
OPERATION.



KNOW YOUR VEHICLE BEFORE YOU BEGING RIDING!

Read this manual thoroughly referring to the various areas which are being discussed on your machine. Operating this vehicle carries with it responsibilities for your personal safety, the safety of others, and the protection of our environment.

NOTE: Illustrations used in this manual are for general representation only. Your model may differ.

2. UNDERSTANDING WARNINGS

SAFETY ALERT

WARNINGS identify special instructions or procedures which, if not correctly followed, could result in personal injury, or loss of life. Read all **WARNINGS** in this manual carefully. Follow their instructions to remain safe.

The following precautionary signal words are used throughout this manual to convey the following messages:



This is the safety alert symbol. When you see this symbol on your machine or in this manual, be alert to the potential for personal injury. Your safety is involved!



WARNING

Indicates a potential hazard which could result in severe injury or death.



CAUTION

Indicates a potential hazard which may result in minor personal injury or damage to the VEHICLE.



CAUTION

Indicates a situation that can result in damage to the machine.

NOTE The word “NOTE” in this manual will alert you to key information or instructions.

3. SAFETY WARNING

NOTE:

Warning decals have been placed on the vehicle for your protection. Read and follow the instructions on each decal carefully. In the event any decal becomes illegible or comes off, contact your dealer for a replacement.

3. SAFETY WARNING

1

 **WARNING**

Improper use can result in Server INJURY or DEATH

BE PREPARED

- Fasten seat belts.
- Wear an approved helmet and protective gear.
- Each rider must be able to sit with back against seat.

Feet flat on floor [and foot rests], and hands on steering wheel or handhold(s), [where equipped], Stay completely inside the vehicle.

Drive Responsibly

Avoid loss of control and rollovers:

- Avoid abrupt maneuvers, sideways sliding, skidding, or fishtailing, and never do donuts.
- Slow down before entering a turn.
- Plan for hills, rough terrain, ruts, and other changes in traction and terrain. Avoid paved surfaces.
- Avoid side hilling (ride across slopes).

Be Sure Riders Pay Attention and Plan Ahead
If you think or feel the vehicle may tip or roll, reduce your risk to injury:

- Keep a firm grip on the steering wheel or handholds and brace yourself.
- Do not put any part or your body outside of the vehicle for any reason.

Require Proper Use of Your Vehicle
Do you part to prevent injuries:

- Do not allow careless or reckless driving.
- Make sure operators are 16 or older with a valid driver's license.
- Do not let people drive or ride after using alcohol or drugs.
- Do not allow operation on public roads (unless designated for off-highway vehicle access)—collisions with cars and trucks can occur.
- Do not exceed seating capacity:



ALWAYS USE AN APPROVED HELMET AND PROTECTIVE GEAR



NEVER USE PUBLIC ROADS OR PAVEMENT



NEVER USE WITH DRUGS OR ALCOHOL

[Locate and] Read [Owner's Manual]
Follow All Instruction and Warnings
[Reserved for Reference to Other Sources of Safety Information]

2

 **WARNING**

Improper tire pressure can cause the vehicle out of control, resulting in serious personal injury or death.

Always keep the tire pressure within the specified range.

•Tire pressure:

Front wheel: 12psi (87kPa)

Rear wheel : 14psi (93kPa)

3

 **WARNING**



MAX
220 lbs
100 kg







3. SAFETY WARNING

4

 **WARNING**

- Charge the battery every month
- Charge the battery after use
- Stop charging batteries when the charging indication light becomes green
- Charge should not exceed 10 hours

5

 **WARNING**

The protective frame cannot protect the occupant in all accidents, including rollover

6

 **WARNING**

Max Load Capacity 50 lbs

4. DAILY PRE-RIDE INSPECTION



WARNING

You must inspect your vehicle each time before riding to ensure it is in proper working order. If proper inspection is not done, severe injury or death could result.

Use the following checklist to verify your machine is in proper working order each time you ride.

ITEM/ INSPECTION PROCEDURE

1. Tire— check condition and pressures.

2. Battery— Check whether the battery is abnormal, whether the wiring is secure, and whether the terminal is protected.

3. All brakes—check fluid level, check operation, adjustment (includes parking brake).

● Brake pedal

Check for correct brake pedal free play. If the brake pedal free play is incorrect, have an authorized dealer adjust it. Check the operation of the brake pedal. It should move smoothly and there should be a firm feeling when the brakes are applied. If not, have the vehicle inspected by your dealer.

● Brake fluid leakage

Check to see if any brake fluid is leaking out of the pipe joints or the brake fluid reservoir. Apply the brakes firmly for one minute. If there is any leakage, have the vehicle inspected by an authorized dealer.

● Brake fluid level

Check the brake fluid level.

Add fluid if necessary.

● Brake operation

Test the brakes at slow speed after starting out to make sure they are working properly. If the brakes do not provide proper braking performance, inspect the brake system.

4. Accelerator pedal— check for free operation, closing and free play.

Check to see that the accelerator pedal operates correctly. It must operate smoothly and fully spring back to the idle position when be released.

Have an authorized dealer repair as necessary for proper operation.

4. DAILY PRE-RIDE INSPECTION

5. Headlight / Taillight / Brake light— check operation of all indicator lights and switches.

6. Wheels— check for tightness of wheel nuts and axle nuts, and check for those axle nuts are secured by cotter pins.

Check balance/ damage/ run out. Have an authorized dealer repair/ replace if necessary.

Check bearing assemblies for looseness/damage. Have an authorized dealer replace if damaged.

7. Steering— check for free operation noting any unusual looseness in any area.

Park on level ground. Turn the steering wheel right and left. Check for excessive free play, abnormal noises, or a rough feeling. Have an authorized dealer repair as necessary for proper operation.

8. Loose parts—visually inspect vehicle for any damaged components or loose nuts/bolts or fasteners.

Always check the tightness of chassis fittings and fasteners before a ride. Take the vehicle to your dealer for correct tightening torque.

9. Operator's and passenger's helmets, goggles and clothing.

10. Seat belts— Check for proper operation and belt wear.

Make sure that both seat belts are not frayed or damaged. The seat belt must move smoothly when pulled out and retract on its own when released. The latch plate should click securely into the buckle and release when the release button is pushed firmly. Clean off any dirt or mud which could affect operation. Have an authorized dealer repair as necessary for proper operation.

5. OPERATION WARNINGS



WARNING

POTENTIAL HAZARD

Plug and remove electrical components in the energized state

WHAT CAN HAPPEN

When plugging and unplugging electrical components, it may cause instantaneous bad contact and discharge phenomenon, which will form signal interference, damage electrical components, even the phenomenon of vehicle out of control, runaway, causing serious injury or death.

HOW TO AVOID THE HAZARD

Be sure to ensure that the electric door lock of the vehicle is closed when checking and inserting the nylon plug-in of the electrical components.



WARNING

POTENTIAL HAZARD

Wash the vehicle with plenty of water or wash the electrical components and batteries with a cloth with water.

WHAT CAN HAPPEN

Water droplets may cause short circuits, burn electrical circuits and electrical components, cause fires and leakage, and cause serious injury or death to people.

HOW TO AVOID THE HAZARD

Do not wash the vehicle with a large amount of water or wash the electrical components and batteries with a damp cloth to protect the vehicle from a large amount of water spray.



WARNING

POTENTIAL HAZARD

Malfunction of the accelerator pedal.

WHAT CAN HAPPEN

The accelerator pedal could be hard to operate, making it difficult to speed up or slow down when you need to. This could cause an accident.

HOW TO AVOID THE HAZARD

Check the operation of the accelerator pedal before you start the engine. If it does

5. OPERATION WARNINGS

not work smoothly, check for the cause. Correct the problem before operating the vehicle. Consult an authorized dealer if you can't find or solve the problem yourself.



WARNING

POTENTIAL HAZARD

Not wearing the seat belt.

Wear the seat belt improperly.

WHAT CAN HAPPEN

There is increased risk of being killed or seriously injured in an accident.

HOW TO AVOID THE HAZARD

Always wear your seat belt when riding in the vehicle.

Be sure the seat belt is close-fitting across your hips and chest and is latched securely.



WARNING

POTENTIAL HAZARD

Try to stop the tipping vehicle with your arm or leg .

WHAT CAN HAPPEN

You could be severely injured. You could suffer a crushed hand, arm, leg, or foot.

HOW TO AVOID THE HAZARD

You must keep your arms and legs inside the vehicle until it has stopped moving.

As with any off-road-capable vehicle, there is a risk of tip which can be over or rollover on certain conditions. Uneven terrain or slopes which pitch the vehicle sideways, turning too fast or sharp, or a combination of conditions increase the risk of tip over.

If you are in a situation where the vehicle is tipping over, do not put your arm or/ and leg outside the vehicle, do not try to stop tipping with your arm or leg. You could be severely injured. You could suffer a crushed hand, arm, leg, or foot, if part of your body is caught underneath the vehicle.



WARNING

POTENTIAL HAZARD

Drive with improperly operating brakes.

WHAT CAN HAPPEN

5. OPERATION WARNINGS

You could lose braking ability, which could lead to an accident.

HOW TO AVOID THE HAZARD

Always check the brakes at the start of every ride. Do not operate the vehicle if you find any problem with the brakes. If a problem cannot be corrected by the adjustment procedures provided in this manual, have the vehicle inspected by an authorized dealer.



WARNING

POTENTIAL HAZARD

Operate vehicle without being familiar with all controls.

WHAT CAN HAPPEN

Loss of control, which could cause an accident or injury.

HOW TO AVOID THE HAZARD

Read the Owner's Manual carefully. If there is a control or function you do not understand, ask our authorized dealer.



WARNING

POTENTIAL HAZARD

Improper charging.

WHAT CAN HAPPEN

Batteries or car chargers inflate, get damaged or explode, which can cause fires and serious injuries.

HOW TO AVOID THE HAZARD

Charge using the specified power supply and plug. Disconnect the power supply when the charging indicator is green. If the charging indicator, charging socket or car charger is faulty and cannot be charged, please contact the authorized dealer in time.



WARNING

POTENTIAL HAZARD

Operate this vehicle with improper modifications.

WHAT CAN HAPPEN

Improper installation of accessories or modification of this vehicle may cause changes in handling which in some situations could lead to an accident.

5. OPERATION WARNINGS

HOW TO AVOID THE HAZARD

Never modify this vehicle through improper installation or use of accessories. All parts and accessories added to this vehicle should be genuine parts or equivalent components designed for use on this vehicle and should be installed and used according to instructions. If you have questions, consult an authorized dealer.



WARNING

POTENTIAL HAZARD

Operate/ ride this vehicle without wearing an approved helmet, eye protection and protective clothing.

WHAT CAN HAPPEN

Operating/ riding without an approved helmet increases your chances of a severe head injury or death in the event of an accident.

Operating/ riding without eye protection can result in an accident and increases your chances of a severe injury in the event of an accident.

HOW TO AVOID THE HAZARD

Always wear an approved helmet which fits properly.

You should also wear: eye protection (goggles or face shield); gloves; boots; long-sleeved shirt or jacket; and long pants.



WARNING

POTENTIAL HAZARD

Operate this vehicle after consuming alcohol or drugs.

WHAT CAN HAPPEN

Could seriously affect your judgment.

Could cause you to react more slowly.

Could affect your balance and perception.

Could result in an accident.

HOW TO AVOID THE HAZARD

Never consume alcohol or drugs before or while driving this vehicle.

5. OPERATION WARNINGS



WARNING

POTENTIAL HAZARD

Operate this vehicle at excessive speeds.

WHAT CAN HAPPEN

Increases your chances of losing control of the vehicle, which can result in an accident.

HOW TO AVOID THE HAZARD

Always travel at a speed which is proper for the terrain, visibility and operating conditions; and your experience.



WARNING

POTENTIAL HAZARD

Failure to inspect the vehicle before operating.

Failure to properly maintain the vehicle.

WHAT CAN HAPPEN

Increases the possibility of an accident or equipment damage.

HOW TO AVOID THE HAZARD

Always inspect your vehicle each time you use it to make sure the vehicle is in safe operating condition.

Always follow the inspection and maintenance procedures and schedules described in the Owner's Manual.



WARNING

POTENTIAL HAZARD

Remove hands from steering wheel or feet from footrests during operation.

WHAT CAN HAPPEN

Removing even one hand or foot can reduce your ability to control the vehicle or could cause you to lose your balance and fall off the vehicle.

HOW TO AVOID THE HAZARD

Always keep both hands on the steering wheel and both feet on the footrests of your VEHICLE during operation.

5. OPERATION WARNINGS



WARNING

POTENTIAL HAZARD

Failure to use extra care when operating this VEHICLE on unfamiliar terrain.

WHAT CAN HAPPEN

You can come upon hidden rocks, bumps, or holes, without enough time to react. Could result in the VEHICLE overturning or going out of control.

HOW TO AVOID THE HAZARD

Go slowly and be extra careful when operating on unfamiliar terrain. Always be alert to changing terrain conditions when operating the VEHICLE.



WARNING

POTENTIAL HAZARD

Turn improperly.

WHAT CAN HAPPEN

VEHICLE could go out of control, causing a collision or overturn.

HOW TO AVOID THE HAZARD

Always follow proper procedures for turning as described in the Owner's Manual. Practice of turning at low speeds before attempting to turn at faster speeds. Do not turn at excessive speed.



WARNING

POTENTIAL HAZARD

Improperly operate over obstacles.

WHAT CAN HAPPEN

Could cause loss of control or a collision. Could cause the VEHICLE to overturn.

HOW TO AVOID THE HAZARD

Before operating in a new area, check for obstacles. Use extreme caution when riding over large obstacles, such as large rocks or fallen trees. If you cannot avoid obstacles, always follow proper procedures as described in the Owner's Manual.

5. OPERATION WARNINGS



WARNING

POTENTIAL HAZARD

Skidding or sliding.

WHAT CAN HAPPEN

You may lose control of the VEHICLE.

You may also regain traction unexpectedly, which may cause the VEHICLE to overturn.

HOW TO AVOID THE HAZARD

On slippery surfaces, such as ice, go slowly and be very cautious in order to reduce the chance of skidding or sliding out of control.



WARNING

POTENTIAL HAZARD

Operate this VEHICLE through deep or fast flowing water.

WHAT CAN HAPPEN

Tires may float, causing loss of traction and loss of control, which could lead to an accident.

HOW TO AVOID THE HAZARD

Never operating the VEHICLE through water which exceeds the recommended maximum depth in this manual.

Avoid operating the VEHICLE through deep or fast flowing water. If you cannot avoid water, go slowly, balance your weight carefully avoiding sudden movement, maintain a slow and steady forward motion, do not make sudden turns or stops, and do not make sudden throttle changes.

Remember that wet brakes may have reduced stopping ability.

Test your brakes after leaving water. If necessary, apply them several times to let friction dry out the pads.



WARNING

POTENTIAL HAZARD

Operate this VEHICLE with improper tires, or with improper or uneven tire pressure.

WHAT CAN HAPPEN

Use of improper tires on this VEHICLE, or operation of this VEHICLE with improper or uneven tire pressure, may cause loss of control, and increases the risk of an accident.

5. OPERATION WARNINGS

HOW TO AVOID THE HAZARD

Always use the size and type tires specified in the Owner's Manual for this vehicle.

Always maintain proper tire pressure as described in the Owner's Manual.

Use proper pressures stated on the side wall of the tire when seating the tire beads.

Higher pressures may cause the tire to burst. Inflate the tires very slowly and carefully.

Fast inflation could cause the tire to burst.



WARNING

After a rollover or an accident, have a qualified service dealer check the complete machine including, but not limited to, brakes, throttle and steering for possible damage.



WARNING

Safe operation of this rider active vehicle requires good judgment and physical skills. Persons with cognitive or physical disabilities who operate this vehicle have an increased risk of overturns and loss of control which could result in severe injury or death.

7. CONTROL AND PARTS FUNCTIONS

ELECTRICAL SWITCHES

Switch On Panel (U.S.)

1. Key switch
2. Near and far light switch
3. Double flash switch
6. The USB charging port

1. Key switch

ON: Provide all 12V electrical power supply and connect the DC contactor coil.

OFF: All circuits are turned OFF. In this case, the key can be pulled out.

2. Near and far light switch

Turn on the high or low light of the headlight.

3. Gear switch

Forward, neutral and reverse gear three gears. When you press the accelerator pedal in forward gear, the vehicle moves forward; When the accelerator pedal is pressed in reverse gear, the vehicle will drive backward, and the instrument reversing light will be on, and the reversing buzzer will alarm; In neutral, the vehicle does not move even when the gas pedal is pressed.

4. Lighting switch

Used for front spotlights.

5. Double flash switch

Used for front and rear turn signal work.

6. USB charging port

Charging port: Placed above the dashboard on the left side, you can use the charging port to charge.

The charging port is rated at 5V2A, and exceeding this limit will blow out the fuse.

When washing the car, do not spill water into the charging port.

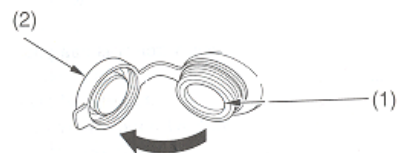

(1) accessory socket (2) cap

7. CONTROL AND PARTS FUNCTIONS

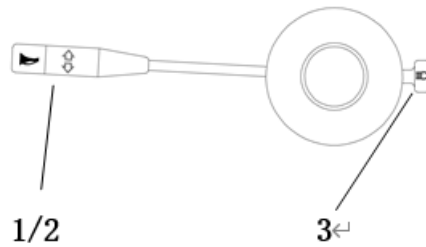

Combination switch

1. Turn signal switch: up and down for left and right turn signal work
2. Horn switch: honk back to work
3. Position light switch: Turn on the headlight and rear taillight position light

ACCELERATOR PEDAL

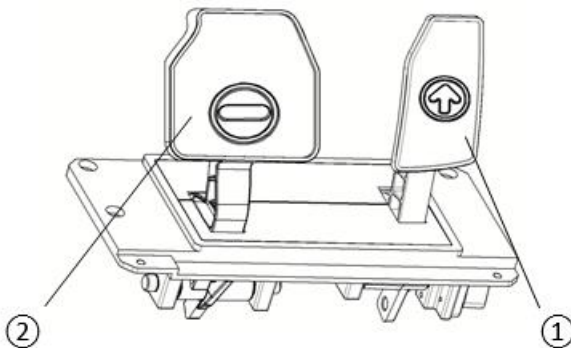

1. Accelerator pedal

Check the accelerator pedal before starting to make sure it is running smoothly. Make sure the pedal is fully returned to free position when it is released.

2. Brake pedal

Step on the brake pedal to slow down or stop

With the brakes on, the brake bulb in the taillight should light up.

1. Accelerator pedal

Press the accelerator pedal down to increase engine speed. Spring pressure returns the pedal to the rest position when released. Always check that the accelerator pedal returns normally before starting the engine.



WARNING

Never operate the VEHICLE with a spongy feeling brake pedal. Operating the

7. CONTROL AND PARTS FUNCTIONS

VEHICLE with a spongy brake pedal can result in loss of braking. Loss of braking could cause an accident.

PARKING PEDAL



The parking pedal is located on the left side of the vehicle floor to prevent movement during parking. Stepping on the parking pedal can achieve parking, if stepping on the parking pedal and stepping on the accelerator pedal, then the vehicle buzzer will alarm. To release the parking pump, press the parking pedal down again. Be sure to fully release the parking pump before departure as this can lead to poor performance and excessive wear of the brake pads.

SEAT BELTS

This vehicle is equipped with three-point seat belts for both the operator and passenger. Always wear the seat belt while riding in the vehicle.

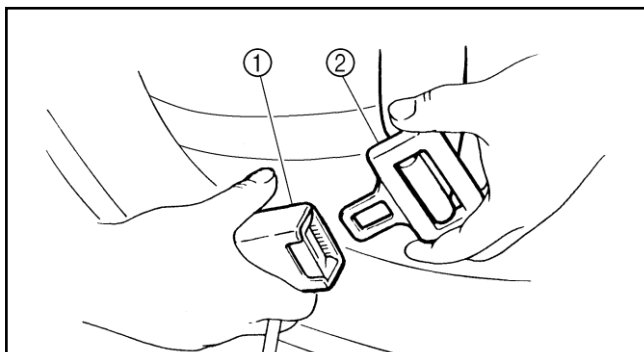

1. Buckle
2. Latch plate

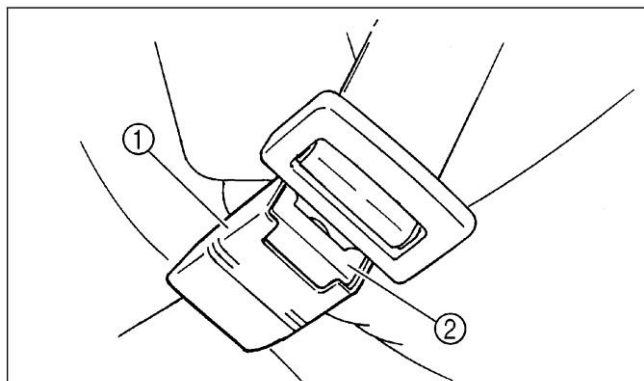

1. Buckle
2. Release button

7. CONTROL AND PARTS FUNCTIONS

To Wear The Seat Belt Properly, do the following:

1. Hold the latch plate as you pull the belt across your lap and chest. Make sure the belt is not twisted and is not caught on any portion of the vehicle, your clothing, or any equipment you are carrying.
2. Push the latch plate into the buckle until it clicks. Pull up on the latch plate to make sure it is secure.
3. Put the lap portion of the belt low on your hips. Push down on the buckle end of the belt as you pull up on the shoulder part so the belt is snug across your hips.
4. Position the shoulder belt over your shoulder and across your chest. The shoulder belt should fit against your chest. If it is loose, pull the belt out all the way and then let it retract.

To Release The Buckle, firmly press the release button.



WARNING

POTENTIAL HAZARD

Not wearing the seat belt.

Wear the seat belt improperly.

WHAT CAN HAPPEN

There is increased risk of being killed or seriously injured in an accident.

HOW TO AVOID THE HAZARD

Always wear your seat belt when riding in the vehicle.

Be sure the seat belt is close-fitting across your hips and chest and is latched securely.

TRAILER HITCH BRACKET

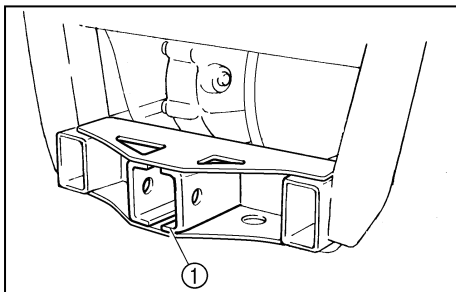

① Trailer hitch bracket

This vehicle is equipped with a receiver bracket for a standard trailer hitch.

8. RIDING WEAR

SAFE RIDING WEAR

Always wear clothing suitable to the type of riding you are doing. VEHICLE riding requires special protective clothing which will make you feel more comfortable and reduce chances of injury.

1. Helmet

Your helmet is the most important piece of protective gear for safe riding. A helmet can prevent a severe head injury.

Select an approved off-road motorcycle -type helmets that fit properly.

2. Eye Protection

A pair of goggles or helmet face should offer the best protection for your eyes.

3. Gloves (off-road style)

4. Boots

A pair of strong over the calf type boots with heels, such as motocross boots.

5. Clothing

To protect your body, long sleeves and pants should always be worn. Riding pants with kneepads, a jersey and shoulder pads provide the best protection.

8. RIDING WEAR



WARNING

POTENTIAL HAZARD

Operate this vehicle without wearing an approved motorcycle helmet, eye protection, and protective clothing.

WHAT CAN HAPPEN

Operating without an approved motorcycle helmet increases your chances of a severe head injury or death in the event of an accident.

Operating without eye protection can result in an accident and increases your chances of a severe injury in the event of an accident.

HOW TO AVOID THE HAZARD

Always wear an approved motorcycle helmet that fits properly. You should also wear: eye protection (goggles or face shield), gloves, boots, long-sleeved shirt or jacket long pants.

9. BATTERY

Battery parameters

The battery pack consists of six 8V 155AH (4-EVF-155) cells

Battery pack: 48V and 155AH

Check for appearance and connection

1. The shell, cover of the battery has no swelling, acid leakage or damage.
2. Check whether the battery is dirt;
3. Check whether the connection wire or terminal is rusty
4. Check whether the connection bolt is loose

Avoid short circuit



WARNING

The short circuit current can reach up to thousands of ampere,. As a result, a large amount of heat is generated in the connecting part of the short circuit, it will damage the battery, leakage of liquid and even explosion, cause serious injury or death.

In order to avoid short circuit, you need to be extra careful when you install or remove batteries and using insulation tools. The cable for connecting the battery cannot be placed casually, it may cause short circuit.

The battery terminal screws should be covered by insulating cap.

Arrangement of cable should avoid overlapping pressure to produce a breakdown.

Charging

Car charger is located at the bottom of the cargo box on the right side, charging interface is located at the left side of the cab seat cushion.

A charging cable is provided with the car, please use the original charging cable to charge; Charging voltage 220V.

Before charging, check whether the charging port, charging cable plug, and socket

9. BATTERY

are damaged, stained, or water stained to prevent short circuit.

There is a charging indicator on the dashboard, indicating the power range: red (< 80%);

Yellow (> 80%);

Green (100%);

When the indicator light is green, it indicates that the battery is fully charged. You can unplug the charging cable.

Maintenance

1. The storage battery shall not be stored without loss of power. If the battery is used up and idle for a few days, it will be charged again. Battery loss storage will seriously affect the service life, if the idle time is longer, the battery damage is more serious.

2. Check regularly if the range is greatly reduced. Use a multimeter to check the voltage of each battery. Generally, the voltage of a single battery will reach more than 8.7V when fully charged; If the voltage of one of the batteries is significantly lower than that of the others, the battery behind may have a short circuit inside the single cell. At this time, request the authorized dealer to check and deal with it, so as not to damage the other batteries. Secondly, check the charging parameters of the charger.

3. Prevent exposure to the sun

The sun exposure will make the battery temperature rise, the battery internal pressure increase and the pressure limiting valve open, increase the water loss, and reduce the gas potential of the battery, thereby affecting the battery life

4. At the beginning of the vehicle, the accelerator pedal should be gently pressed to start the vehicle with a small current until the vehicle runs at a uniform speed. If the throttle pedal is stepped on to the bottom, the motor current rapidly increases, so that the battery discharge too fast, the voltage quickly drops, resulting in the reduction of battery life.

5. It is a normal phenomenon that the battery capacity decreases with the decrease of temperature in winter. With 20°C as the standard, the capacity is generally 80%

9. BATTERY

when -10°C .

6. Keep the battery surface clean for a long time, and the vehicle should be parked in a cool, ventilated and dry place.

7. When placing the vehicle for a long time, the battery of the vehicle must be fully charged first, and the battery should be replenished once a month.

8. The original car charger is matched by the battery, do not change the charger at will.

10. MAINTENANCE



CAUTION

Due to the nature of the adjustments marked with a D on the following chart, it is recommended that service be performed by an authorized dealer.

More often under severe use, such as dirty or wet conditions to purge water or dirt contamination from grease fittings and other critical components.

PERIODIC MAINTENANCE SCHEDULE

Careful periodic maintenance will help keep your vehicle in the safest, most reliable condition. Inspection, adjustment and lubrication intervals of important components are explained in the following chart on the following pages.

NOTE:

Maintenance intervals are based upon average riding conditions and an average vehicle speed of approximately 16 km/ 10 miles per hour.

However, keep in mind that if the vehicle isn't used for a long period of time, the month maintenance intervals should be followed.

Vehicles subjected to severe use, such as operation in wet or dusty areas, should be inspected and serviced more frequently.

Inspect, clean, lubricate, adjust or replace parts as necessary.

NOTE:

Inspection may reveal the need for replacement parts. Always use genuine parts available from your dealer.

Service and adjustments are critical. If you are not familiar with safe service and adjustment procedures, have a qualified dealer perform these operations.

10. MAINTENANCE

| | Item | Hours | When | Remarks |
|---|-----------------------------------|----------|----------|---|
| ● | Brake System | Pre-ride | Pre-ride | Pre-ride inspection item |
| | Electronic Accelerator pedal | Pre-ride | Pre-ride | Pre-ride inspection item |
| ● | Tires | Pre-ride | Pre-ride | Inspect daily, pre-ride inspection item |
| ● | Front and Rear Wheels/ Hubs | Pre-ride | Pre-ride | Pre-ride inspection item |
| ● | Steering | Pre-ride | Pre-ride | Inspect daily, lubricate |
| D | Wheels bearings | 10 hrs | Monthly | Check for looseness/ damage. Replace if damaged. |
| | Frame nuts, bolts fasteners | Pre-ride | Pre-ride | Pre-ride inspection item |
| | Headlamp Inspection | Daily | Daily | Check operation daily; apply dielectric grease to connector when replaced |
| | Tail/ indicator lamp inspection | Daily | Daily | Check operation daily; apply dielectric grease to socket when replaced |
| ● | Air Filter-Main Element | Weekly | Weekly | Inspect –Replace if necessary |
| ● | Transmission Oil Level | 20 hrs | Monthly | Inspect monthly; change annually |
| | Battery | Monthly | Monthly | Check/clean Terminals; Check damage and deformation |
| D | Brake pad wear | 10 hrs | Monthly | Inspect periodically |
| ● | Rear Gear case Oil | 100 hrs | Monthly | Check monthly and change annually |
| ● | General Lubrication | 50 hrs | 3 months | Lubricate all fittings, pivots, cables, etc. |
| D | Throttle Cable/ Accelerator pedal | 20 hrs | monthly | Inspect –adjust, lubricate, replace if necessary; pre-ride inspection item |
| D | Steering system | 50 hrs | 6 months | Check operation and for looseness, worn, damage, binding feeling / Adjust, repair, Replace if necessary. Check toe alignment /Adjust if necessary. |

10. MAINTENANCE

| | | | | |
|---|-------------------------------------|-------------|-------------|--|
| D | Front Axle | 10 hrs | Monthly | Check for/ Bearing seals/ looseness/ damage. |
| ● | Rear Axle | 50 hrs | 6 months | Inspect bearings, Lube |
| ● | Front Prop Shaft & Shaft Yoke | 50 hrs | 6 months | Check for looseness/ damage. |
| ● | Rear Prop Shaft, Shaft Yoke & Boots | 50 hrs | 6 months | Check for/ boots/ looseness/ damage. |
| ● | Front Suspension | 50 hrs | 6 months | Inspect-lubricate, tighten fasteners |
| ● | Rear Suspension | 50 hrs | 6 months | Inspect, tighten fasteners |
| D | Brake fluid | 200 hrs | 24 months | Change every two years |
| | Headlight Aim | As required | As required | Adjust if necessary |
| ● | Car charger | Monthly | Monthly | Check for heat/ cleanliness Avoid water entry |

LUBRICATION RECOMMENDATIONS

| | Item | Lube Rec | Method | Frequency |
|--|--------------------|------------------|--|--|
| | 2.Brake Fluid | DOT 3 Only | Maintain level Between fill lines. See "7.CONTROL" | As require; change every two years or 200 hours |
| | 3.Transmission Oil | SAE 80W/90GL5 | Add to proper level on dipstick | Change annually or at 100 hours |

| | Item | Lube Rec | Method | Frequency |
|---|---------------------------|----------|---|-------------------------------|
| ● | 6.Steering system | Grease | Lubricate the pivoting and sliding parts | Every 3 months or 50 hours |
| ● | 7.Tie rods | Grease | Grease | Semi-annually |
| ● | 8.Shift Linkages | Grease | Locate fittings and Grease | Semi-annually |
| ● | 9.Front Wheel bearings | Inspect | Inspect and replace bearings if necessary | Semi-annually |

10. MAINTENANCE

| | | | | |
|---|---|--------|---|----------------------------|
| ● | 10. Ball joints | Grease | Inspect, Locate fittings and Grease, or replace it if necessary | Semi-annually |
| ● | 11. Prop Shaft & Shaft Yoke, Spline Joint | Grease | Locate fitting and Grease | Semi-annually |
| ● | 12. Rear Axle Bearing | Grease | Grease | Every 3 months or 50 hours |

NOTE:

1. MORE OFTEN UNDER SEVERE USE, SUCH AS WET OR DUSTY CONDITIONS .
2. GREASE: LIGHT WEIGHT LITHIUM-SOAP GREASE.
3. GREASE M: MOLYBDENUM DISULFIDE(MOS₂) GREASE(WATER RESISTANT).
4. *WHEN SUSPENSION ACTION BECOMES STIFF OR AFTER WASHING.
5. HOURS ARE BASED ON 10 MPH(16KM/H) AVERAGE.

PERIODIC MAINTENANCE RECORD

USE THE FOLLOWING CHART TO RECORD PERIODIC MAINTENANCE WORK

| Maintenance Interval Performed | Servicing Date | Servicing Dealer or Person | Remarks |
|--------------------------------|----------------|----------------------------|---------|
| First 5 Hrs | | | |
| 10 Hrs | | | |
| 15 Hrs | | | |
| 20 Hrs | | | |
| 25 Hrs | | | |
| 50 Hrs | | | |
| 75 Hrs | | | |
| 100 Hrs | | | |

10. MAINTENANCE

| | | | |
|--|--|--|--|
| | | | |
| | | | |
| | | | |
| | | | |
| | | | |
| | | | |
| | | | |
| | | | |

THE FOLLOWING ITEMS SHOULD BE CHECKED OCCASIONALLY FOR TIGHTNESS; OR IF THEY HAVE BEEN LOOSENED FOR MAINTENANCE SERVICE.

WHEEL NUT TORQUE SPECIFICATIONS

| Bolt Size | Specification | |
|-----------|---------------|-------|
| M12X1.25 | 50Ft.Lbs | 69N.m |

NOTE: All nuts that have a cotter pin installed must be serviced by an authorized Dealer.

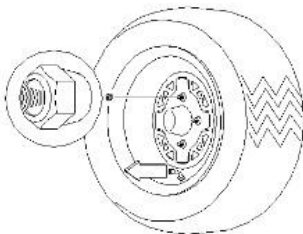

STEERING

Steering Inspection

The steering assembly of the machine should be checked periodically for loose nuts and bolts, worn tie rod ends, worn boots, and damage. Checking routing of all cables, hoses, and wiring to be sure the steering mechanism is not restricted or limited. If any

10. MAINTENANCE

found, have your dealer repair them before riding your vehicle.

The steering assembly should be also checked periodically for free operation, steering should move freely through entire range of travel without binding. Park on level ground. Turn the steering wheel right and left. Check for excessive free play, abnormal noises, or a rough feeling. Have an authorized dealer repair as necessary for proper operation.

Lubricate the pivoting parts.

Recommended lubricant:

Lithium-soap-based grease

CAMBER AND CASTER

The camber and caster are non-adjustable.

TOE ALIGNMENT CHECK



WARNING

Do not attempt to adjust the tie rod for toe alignment. Severe injury or death can result from improper adjustment. Contact your dealer. He/she has the training and tools to Make these adjustment.

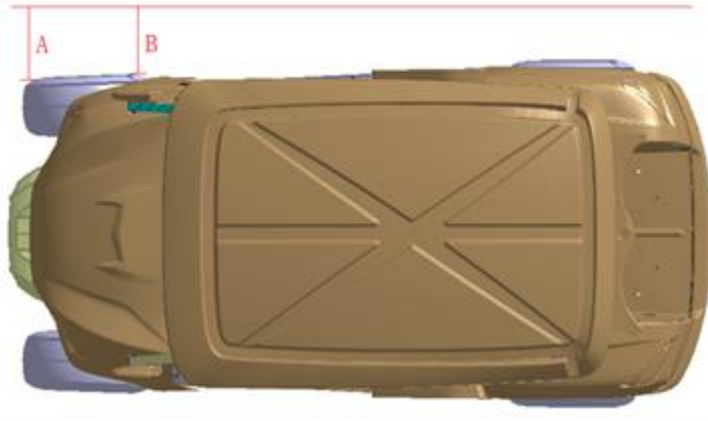
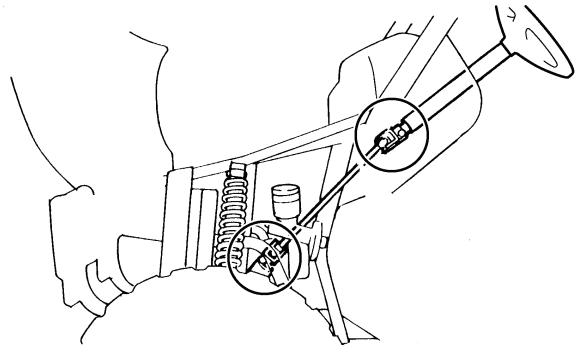

The recommended toe alignment is 1/8" to 1/4" (3 to 6mm) toe out.

1. Set the steering wheel in a straight ahead position and hold them in this position.
2. Measure A and B, A minus B should be 1/16" to 1/8" (1.5 ~ 3mm).
3. If this measurement needs to be adjusted, contact your dealer for service.

10. MAINTENANCE

BRAKES

Front brake



WARNING

Once a bottle of brake fluid is opened, use what is necessary and discard the rest. Do not store or use a partial bottle of brake fluid. Brake fluid is hygroscopic, meaning it rapidly absorbs moisture from the air. This causes the boiling temperature of the brake fluid to drop, which can lead to early brake fade and the possibility of serious injury.

The front brake is hydraulic disc brakes which is depressing the brake pedal. These brakes are self-adjusting and require no adjustment.

The following checks are recommended to keep the brake system in good operating condition. How often they need checking depends upon the type of driving that has been done.

- Keep fluid level in the master cylinder reservoirs as described see "7.Control and part functions". Normal functioning of the diaphragm is to extend into the reservoir as fluid level drops. If the fluid level is low and the diaphragm is not extended, a leak is indicated and the diaphragm should be replaced. Always fill the reservoir as indicated whenever the cover is loosened or removed to insure proper diaphragm operation. Use DOT 3 brake fluid.

- Check brake system for fluid leaks. Check brake for excessive travel or spongy feel.
- Check friction pads for wear, damage and loosened.
- Check security and surface condition of the disc.
- Pads should be changed when friction material is worn to 3/64"(1mm).(A)

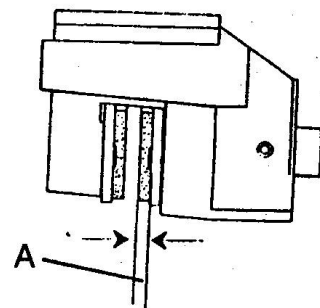

Rear Brake

- The rear brake is a hydraulic disc type brake which is activated by the same pedal which activates the front brake system is self-adjusting and requires no maintenance other than periodic checks of the pads for wear
- Pads should be changed when the friction material is worn to 3/64"(1mm).
- Inspect the brake disc and pad wear surface for excessive wear.

10. MAINTENANCE

Checking the brake fluid level

Insufficient brake fluid may let air enter the brake system, possibly causing the brakes to become ineffective. Before riding, check that the brake fluid is above the minimum level mark and replenish if necessary. A low brake fluid level may indicate worn brake pads and/or brake system leakage. If the brake fluid level is low, be sure to check the brake pads for wear and the brake system for leakage.

The brake fluid reservoir is located under the hood.

- When checking the fluid level, make sure the top of the brake fluid reservoir is level.
- Use only the recommended quality brake fluid. Otherwise, the rubber seals may deteriorate, causing leakage and poor braking performance.

Recommended brake fluid: DOT 4

- Refill with the same type of brake fluid. Mixing fluids may result in a harmful chemical reaction and lead to poor braking performance.
- Be careful that water does not enter the brake fluid reservoir when refilling. Water will significantly lower the boiling point of the fluid and may result in vapor lock.
- Brake fluid may deteriorate painted surfaces or plastic parts. Always clean up spilled fluid immediately.
- Have an authorized dealer inspect the brake system if the brake fluid level goes down.

WHEELS AND TIRES



WARNING

Operating your VEHICLE with worn tires, improperly inflated tires, non-standard tires or improperly installed tire will affect vehicle handling which could cause an accident resulting in serious injury or death.

Follow the safeguards listed below to prevent this type of situation.

Important Safeguards

Improper tire inflation may affect VEHICLE maneuverability.

Do not use improper tires. The use of non-standard size or type tires may affect VEHICLE handling.

Make certain the wheels are installed properly. If wheels are improperly installed it could affect vehicle handling and tire wear.

10. MAINTENANCE

Tire Inspection

When replacing a tire always use original equipment size and type.

LIGHTS



WARNING

Keep your headlights and taillights clean. Poor light while riding can result in an accident causing severe injury or death.



CAUTION

Do not service while headlight is hot. Serious burns may result.
Do not touch a halogen lamp with bare fingers. Oil from your skin leaves a residue, causing a hot spot which will shorten the life of the lamp.

CLEANING YOUR VEHICLE

Keeping your VEHICLE clean will extend the life of various components.

11. TROUBLESHOOTING

NOTE:

THE FOLLOWING TROUBLESHOOTING DOES NOT COVER ALL THE POSSIBLE CAUSES OF TROUBLE. IT SHOULD BE HELPFUL, HOWEVER, AS A GUIDE TO TROUBLESHOOTING. REFER TO THE RELATIVE PROCEDURE IN THIS MANUAL FOR INSPECTION, ADJUSTMENT AND REPLACEMENT OF PARTS. ADJUSTMENT AND REPLACEMENT MUST BE DONE BY YOUR DEALER.

STARTING FAILURE

(LIGHTS AND METER ARE WORKING PROPERLY)

- FAULTY DC CONTACTOR
- AIR SWITCH FAULT OR NOT OPEN
- CABLE MALFUNCTION
- MOTOR CONTROLLER MALFUNCTION
- MOTOR MALFUNCTION
- ACCELERATOR PEDAL FAILURE OR NO RETURN
- ELECTRONIC GEAR SHIFT FAULT

(LIGHTS AND METER ARE NOT WORKING)

- MAIN SWITCH MALFUNCTION
- BURNT OUT, IMPROPER CONNECTION
- CABLE MALFUNCTION
- POOR MEDIUM AND HIGH SPEED PERFORMANCE
- ACCELERATOR PEDAL OUTPUT SIGNAL IS NOT ACCURATE
- BATTERY POWER SHORTAGE OR BATTERY MALFUNCTION
- MOTOR MALFUNCTION
- MOTOR CONTROLLER MALFUNCTION

11. TROUBLESHOOTING

- POOR CONTACT OF ELECTRONIC GEAR
- PARKING HANDLE NOT RELEASED

POOR CHARGING PERFORMANCE

- CHARGING INDICATOR LAMP MALFUNCTION
- CAR CHARGER MALFUNCTION
- CHARGING PLUG AND SOCKET MALFUNCTION
- BATTERY CONNECTION IS NOT RELIABLE
- BATTERY MALFUNCTION
- GEARBOX MALFUNCTION

POOR BRAKING EFFECT

- WORN FRONT HUB BEARING
- WORN BRAKE PAD
- WORN BRAKE DISC
- AIR IN BRAKE FLUID
- LEAKING BRAKE FLUID
- FAULTY MASTER CYLINDER KIT
- FAULTY CALIPER SEAL KIT
- LOOSE UNION BOLT
- BROKEN BRAKE HOSE
- OILY OR GREASY BRAKE PAD
- OILY OR GREASY BRAKE DISC

12. SPECIFICATION

| | | |
|------------------|---|---------------|
| L×W×H | 3030×1345×2170 mm | 119x 53x85 in |
| Wheel Base | 1670mm | 66 in |
| Ground Clearance | 200mm | 7.9 in |
| Dry Weight | 660 kg | 1455 lbs |
| Front Tire | 23×10.5-14 | |
| Rear Tire | 23×10.5-14 | |
| Front Brake | Disc Brake | |
| Rear Brake | Drum Brake | |
| Front Suspension | McPherson Independent Suspension | |
| Rear Suspension | Towing Arm Type Helical Spring Suspension | |
| Motor | 5kw | |
| Battery | 150ah/48v | |